



AS6500-QF_DK

Development Kit User Guide

AS6500-QF_DK User Guide

Revision: 4

Release Date: 2023-06-12

Document Status: Production

Content Guide

Content Guide	2
1 Introduction	3
1.1 Ordering Codes	3
2 Quick Start Guide	3
2.1 Install the Software	4
2.2 Install the Hardware	4
2.3 Start Software	4
3 Hardware Description	4
4 Software Description	5
4.1 Main Window	5
4.1.1 Stop Page	5
4.1.2 REFCLK/SPI Page.....	6
4.2 Menu & Support Windows	6
4.2.1 File.....	6
4.2.2 Tools.....	7
5 Schematics, Layers & BOM	9
6 RoHS Compliance & SciSense Green Statement	12
7 Copyrights & Disclaimer	12
8 Revision information	13

1 Introduction

The AS6500-DK development kit allows customers a quick and intuitive approach to using the AS6500 TDC applications.

The kit includes of four elements:

AS6500-QF_DK_RB reference board V2.0, based on AS6500-BQFM in QFN48 package



PicoProg Lite interface

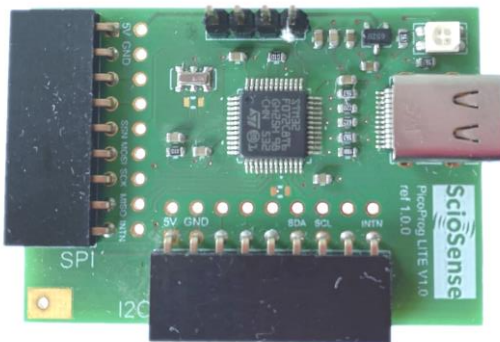

USB-C – USB cable



Figure 1: Functional Blocks

Please download the latest software for the kit from <https://www.downloads.sciosense.com/AS6500>

1.1 Ordering Codes

Table 1: Pin description

Ordering code	Part Number	Description
AS6500-QF_DK V1.0	221050003	AS6500 Development kit including PicoProg Lite and cable
AS6500-QF_DK_RB V2.0	221050002	AS6500 reference board

2 Quick Start Guide

This section describes how to set up the AS6500 development kit, establish basic operation and make first measurements quickly.

2.1 Install the Software

Please download the latest software for the kit from: Link: <https://downloads.sciosense.com/as6500>

- Unzip the package to the desired directory.
- Open “setup.exe” from the unzipped directory.
- Follow the instructions on the screen.

2.2 Install the Hardware

- Connect the PicoProg Lite PCB to the computer by means of the USB cable. The green LED should be on.
- Connect the AS6500 reference board to the PicoProg Lite. Select the connector for SPI communication and one for I2C communication. They are marked accordingly.

2.3 Start Software

- Execute the AS6500 front panel Software. The communication status should be green
- The software starts with an initial configuration, that can be opened the default configuration file config_default.cfg.
- Press “Power On Reset” - “Write Config” - “Init Reset”
- Press “Start Measurement”

The measurement should run and results should be displayed now.

3 Hardware Description

The AS6500-QF_DK_RB board, shown in Figure 2, is a basic board for the 4-channel time-to-digital converter AS6500. The reference clock can be applied from external via pin or from the on-board 5 MHz quartz oscillator (X1).

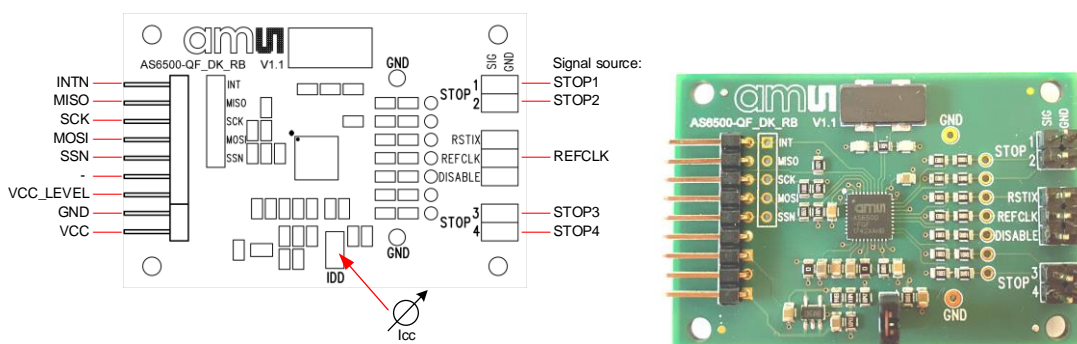

Figure 2: Reference board

The board is connected to the PC via the PicoProg Lite, a USB-to-SPI converter. The PicoProg Lite is registered by the operating system under “Other devices” as “PicoProg LITE V1.0”. It comes with the appropriate firmware for each board on chip by default.

The flat connector connecting the PicoProg Lite and the AS6500-QF_DK_RB includes the power lines and the SPI communication lines. VCC_LEVEL is the voltage feedback but not used with PicoProg Lite.

4 Software Description

This section describes how to quickly set up the AS6500-DK, establish basic operation and make measurements.

4.1 Main Window

The main windows show two pages, one for configuration and one for results display.

4.1.1 Stop Page

On this window major settings are made:

1. Selects the input pins that are used in the application.
2. Enable the internal measurement channels. Each pin refers to minimum one internal channel. Two will be needed in case of channel combination.
3. Select the resolution. High resolution achieves a better single-shot rms noise, but at the cost of pulse-pair resolution.
4. Selects optional channel combination
This can be for better pulse-pair resolution or for pulse width measurement. Both options demand internally two channels per stop pin.
5. Having done the settings, download the configuration and initialize the chip.
6. Start the measurement.
7. At the bottom the results for the four stop channels are displayed.
8. In many cases the differences between the channels are of interest. This can be activated here.

	Results	Filter	Offset	Final Result	Mean	Std Dev
STOP1	000000	none	0 ps	20496 ps	98640 ps	1968.2 ps
STOP2	000000	none	0 ps	20720 ps	98830 ps	1935.7 ps
STOP3	000000	none	0 ps	0 ps	0 ps	0.0 ps
STOP4	000000	none	0 ps	0 ps	0 ps	0.0 ps
DELTA	000000	none	0 ps	200224 ps	200190 ps	40.8 ps
DELTA	000000	none	0 ps	0 ps	0 ps	0.0 ps

Figure 3: Stop page

4.1.2 REFCLK/SPI Page

At this point, after successful completion of the above steps, a basic operation of the kit should be possible.

Parameter REFCLK_DIVISIONS has to be set so that the frequency calculated is the same of the reference clock used (5 MHz for the on-board reference). Then the output data will come with 1 LSB = 1 ps.

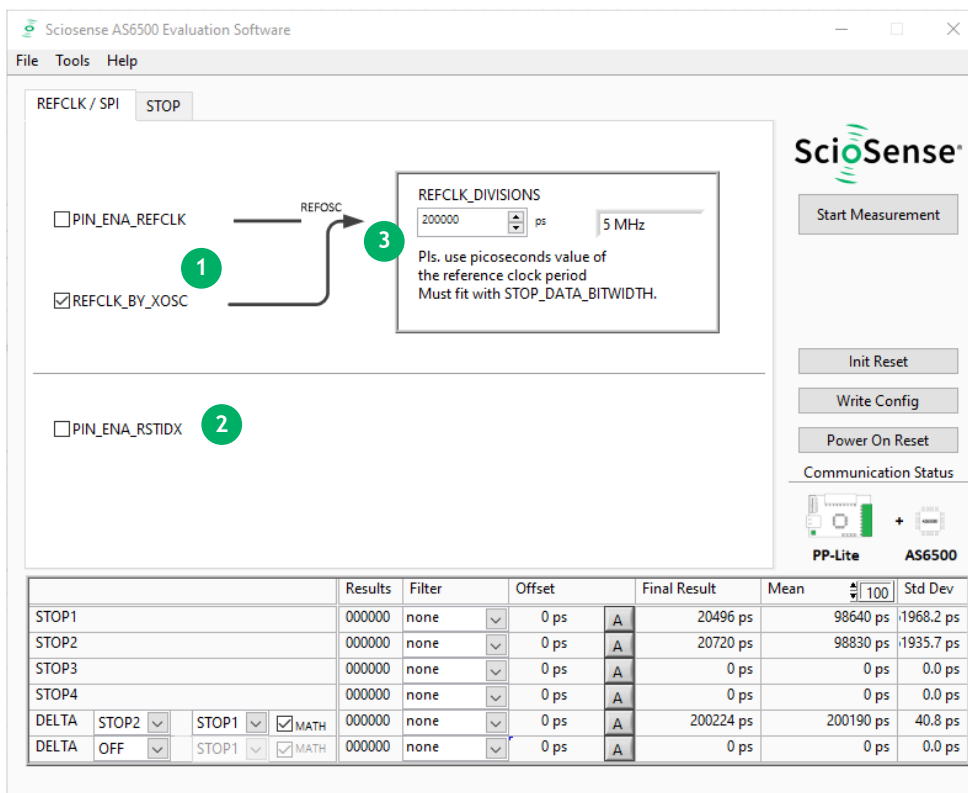

Figure 4: Setup page

4.2 Menu & Support Windows

Beside main window, the software menu allows the opening of other windows. There are some menu items which are redundant to available buttons of main window.

4.2.1 File

- **Load Config**
This dialog box allows the path selection of a configuration file, covering the register settings, necessary for a proper configuration of the AS6500. After opening this file, the control settings are updated in the GUI.
- **Save Config**
This menu item allows the saving of the current GUI control settings into a configuration file
- **Save Graph Data**
Allows to store the measurement data as they are stored in the data buffer for the

graphical display. It is possible to store the STOP data only or the STOP together with the reference numbers.

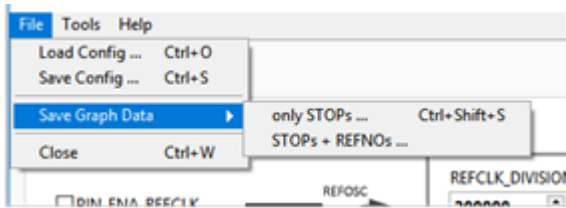

Figure 5: Menu

- Close
Close all open windows of the AS6500-QF_DK Evaluation software.

4.2.2 Tools

- Run Measurement
Same function as “Start/Stop Measurement” button in “Measurement” tab of main window.
- Graph
Opens the window for a graphical display of the measurement data



Figure 6: Menu

- **Registers**
 Opens a separate window for the display and setting of the configuration registers and the display of the read registers.

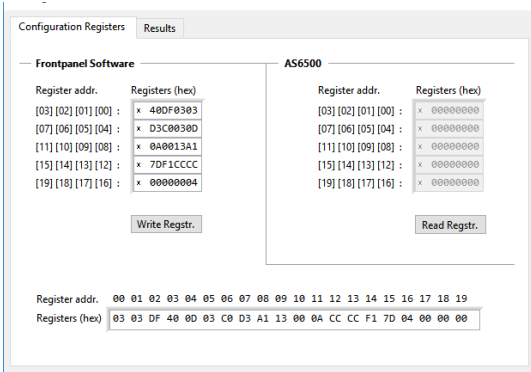

Figure 7: Configuration registers

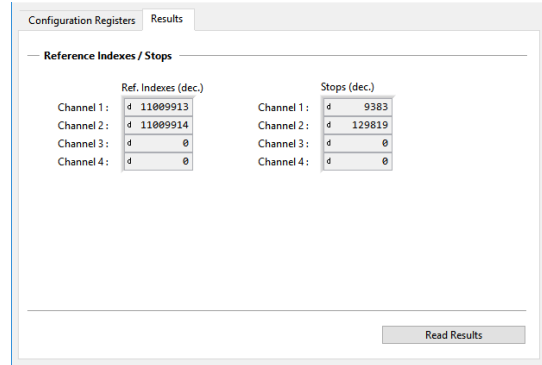

Figure 8: Result registers

5 Schematics, Layers & BOM

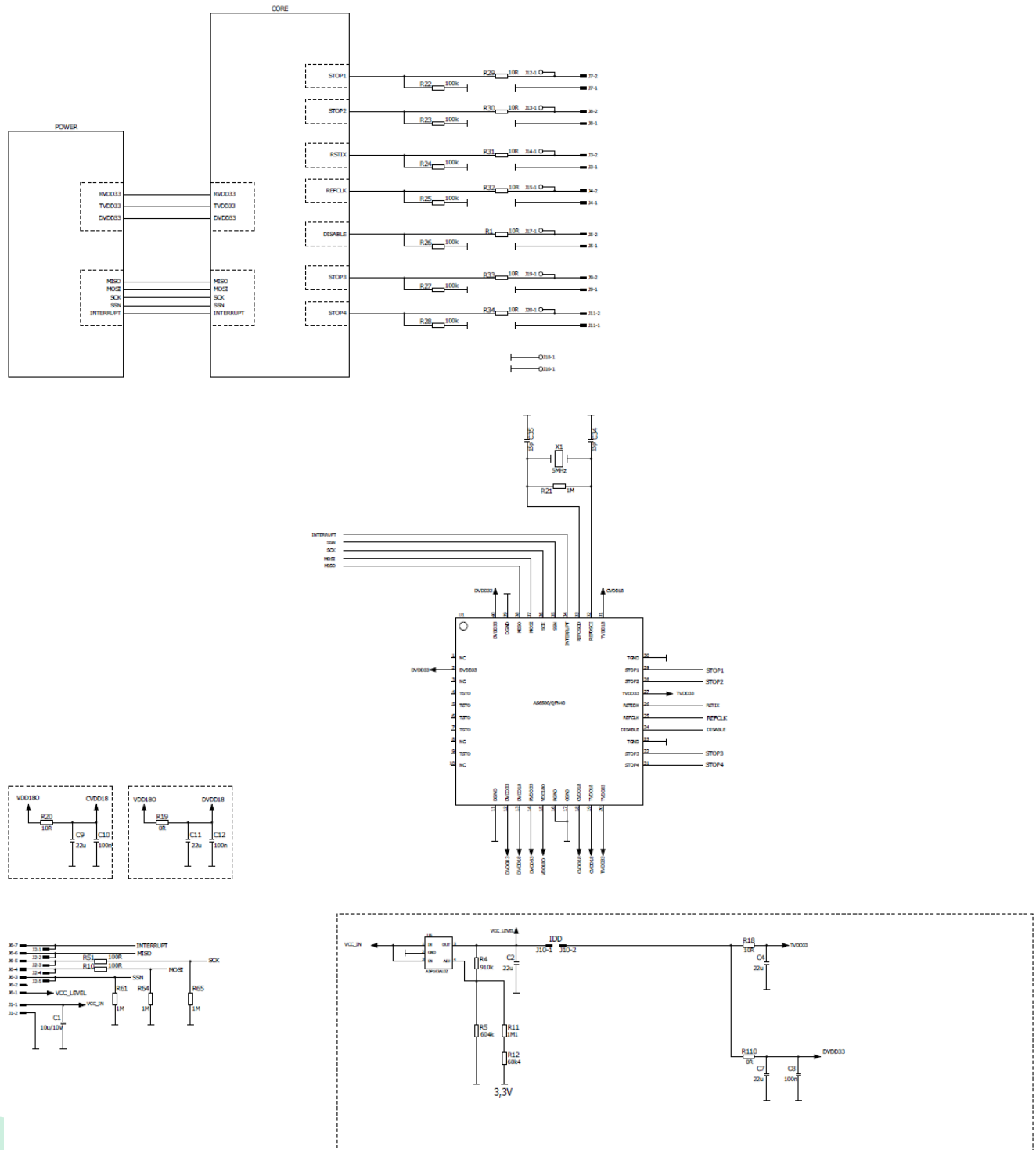
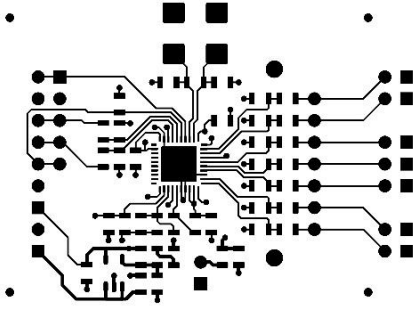
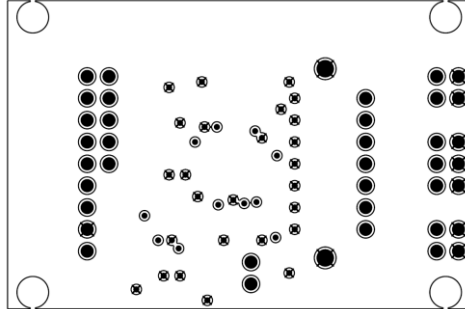

Figure 9: AS6500-QF_DK_RB schematics, version 1.1

Top



Inner Layer 2



Inner Layer 3

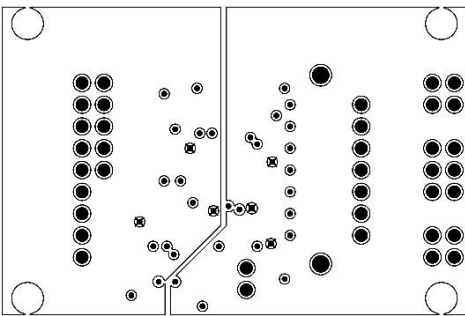

Bottom

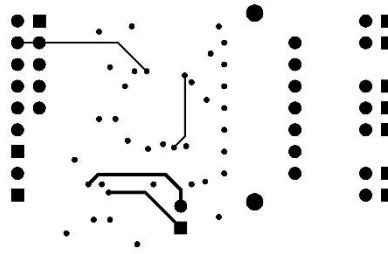

Assembly Top

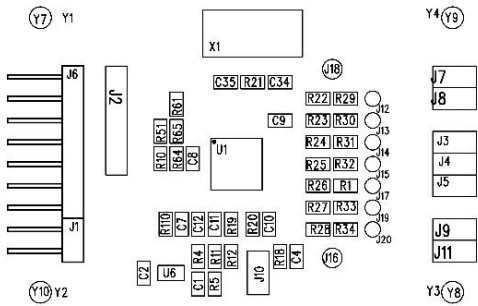

Figure 10: AS6500-QF_DK_RB layout, version 1.1

Table 2: Bill of materials for AS6500-QF_DK_RB

Quantity	Designator	Value	Comment	Footprint
1	U1		AS6500	QFN40
1	U6	3.0 V	ADP163AUJZ Analog Devices	
1	X1	5 MHz	KX-20 Quarts Geyer	
3	C8, C10, C12	100 nF	Chip capacitor	0805
2	C34,C35	15 pF	Chip capacitor	0805
5	C2,C4,C7,C9,C11	22 μ F	Chip capacitor	0805
2	R19,R110	0 Ω	Chip capacitor	0805
2	R10,R51	100 Ω	Chip resistor	0805
7	R22,R23,R24,R25,R26, R27,R28	100 k Ω	Chip resistor	0805
9	R1,R18,R20,R29,R30, R31,R32,R33	1 M Ω	Chip resistor	0805
4	R21,R61,R64,R65	1.1 M Ω	Chip resistor	0805
1	R5	604 k Ω	Chip resistor	0805
1	R12	60.4 k Ω	Chip resistor	0805
1	R4	910 k Ω	Chip resistor	0805
1	R8	10 M Ω	Chip resistor	0805
1	J6	7 x 1 x 90°	Connector	2.54
1	J1	2 x 1 x 90°	Connector	2.54
1	J2	5 x 1 x 180°	Connector	2.54

6 RoHS Compliance & SciSense Green Statement

RoHS: The term RoHS compliant means that Sciosense B.V. products fully comply with current RoHS directives. Our semiconductor products do not contain any chemicals for all 6 substance categories, including the requirement that lead does not exceed 0.1% by weight in homogeneous materials. Where designed to be soldered at high temperatures, RoHS compliant products are suitable for use in specified lead-free processes.

SciSense Green (RoHS compliant and no Sb/Br): SciSense Green defines that in addition to RoHS compliance, our products are free of Bromine (Br) and Antimony (Sb) based flame retardants (Br or Sb do not exceed 0.1% by weight in homogeneous material).

Important Information: The information provided in this statement represents Sciosense B.V. knowledge and belief as of the date that it is provided. Sciosense B.V. bases its knowledge and belief on information provided by third parties, and makes no representation or warranty as to the accuracy of such information. Efforts are underway to better integrate information from third parties. Sciosense B.V. has taken and continues to take reasonable steps to provide representative and accurate information but may not have conducted destructive testing or chemical analysis on incoming materials and chemicals. Sciosense B.V. and Sciosense B.V. suppliers consider certain information to be proprietary, and thus CAS numbers and other limited information may not be available for release.

7 Copyrights & Disclaimer

Copyright **Sciosense B.V High Tech Campus 10, 5656 AE Eindhoven, The Netherlands**. Trademarks Registered. All rights reserved. The material herein may not be reproduced, adapted, merged, translated, stored, or used without the prior written consent of the copyright owner.

Devices sold by Sciosense B.V. are covered by the warranty and patent indemnification provisions appearing in its General Terms of Trade. Sciosense B.V. makes no warranty, express, statutory, implied, or by description regarding the information set forth herein. Sciosense B.V. reserves the right to change specifications and prices at any time and without notice. Therefore, prior to designing this product into a system, it is necessary to check with Sciosense B.V. for current information. This product is intended for use in commercial applications. Applications requiring extended temperature range, unusual environmental requirements, or high reliability applications, such as military, medical life-support or life-sustaining equipment are specifically not recommended without additional processing by Sciosense B.V. for each application. This product is provided by Sciosense B.V. "AS IS" and any express or implied warranties, including, but not limited to the implied warranties of merchantability and fitness for a particular purpose are disclaimed.

Sciosense B.V. shall not be liable to recipient or any third party for any damages, including but not limited to personal injury, property damage, loss of profits, loss of use, interruption of business or indirect, special, incidental or consequential damages, of any kind, in connection with or arising out of the furnishing, performance or use of the technical data herein. No obligation or liability to recipient or any third party shall arise or flow out of Sciosense B.V. rendering of technical or other services.

8 Revision information

Table 3: Revision history

Revision	Date	Comment	Page
1	2019 Mar 14	Change of ownership from ams to SciSense, status to release	All
2	2021 Oct 01	Updated pictures, new SciSense layout	All
3	2023 May	PICOPROG replaced by PicoProg Lite	All

Note(s) and/or Footnote(s):

1. Page and figure numbers for the previous version may differ from page and figure numbers in the current revision.
2. Correction of typographical errors is not explicitly mentioned.

Address: Sciosense B.V.
High Tech Campus 10
5656 AE Eindhoven
The Netherlands

Contact: www.sciosense.com
info@sciosense.com